

Trademarks

Autel®, MaxiCheck®, MaxiDAS®, MaxiDiag®, MaxiRecorder®, MaxiScan®, MaxiSys® and MaxiTPMS® are trademarks of Autel Intelligent Technology Corp., Ltd., registered in China, the United States and other countries. All other marks are trademarks or registered trademarks of their respective holders.

Copyright Information

No part of this manual may be reproduced, stored in a retrieval system or transmitted, in any form or by any means, electronic, mechanical, photocopying, recording, or otherwise, without the prior written permission of Autel.

Disclaimer of Warranties and Limitation of Liabilities

All information, specifications and illustrations in this manual are based on the latest information available at the time of printing.

Autel reserves the right to make changes at any time without notice. While information of this manual has been carefully checked for accuracy, no guarantee is given for the completeness and correctness of the contents, including but not limited to the product specifications, functions, and illustrations.

Autel will not be liable for any direct damages or for any special, incidental, or indirect damages or for any economic consequential damages (including lost profits).

IMPORTANT

Before operating or maintaining this unit, please read this manual carefully, paying extra attention to the safety warnings and precautions.

For Services and Support



<http://pro.autel.com>
www.autel.com



1-855-288-3587/1-855-AUTELUS (North America)
0086-755-86147779 (China)



Support@autel.com

For technical assistance in all other markets, please contact your local selling agent.

Safety Instructions

To prevent personal injury or damage to vehicles and/or the scan tool, read this instruction manual first and observe the following safety precautions at a minimum whenever working on a vehicle.

Work Area Safety

- Always perform automotive testing in a safe environment.
- Keep your work area clean and well lit. Cluttered benches and dark areas may cause accidents.
- Keep clothing, hair, hands, tools, test equipment, etc. away from all moving or hot engine parts.
- Operate the tool in a well-ventilated work area.
- Do not operate the tool in explosive atmospheres, such as in the presence of flammable liquids, gases, or heavy dust.
- Keep a fire extinguisher suitable for gasoline/chemical/electrical fires nearby.
- Do not use the tool around corrosive chemicals which can ruin the photo quality.
- Keep bystanders, children and visitors away while operating the tool.
- Keep the tools dry, clean, free from oil, water and grease. Use a mild detergent on a clean cloth to clean the outside of the tool when necessary.

Electrical Safety

- Avoid body contact with earthed or grounded surfaces such as pipes, radiators, ranges and refrigerators.
- Do not expose the tool to rain or wet conditions. Water entering the tool will increase electric risk.
- Do not abuse the cord. Never use the cord for carrying, pulling, or unplugging the tool. Keep cord away from heat, oil, sharp edges or moving parts.

- If operating the tool in a damp location is unavoidable, use a ground fault circuit interrupter (GFCI) to protect supply.

Personal Safety

- Do not use the tool while tired or under the influence of drugs, alcohol, or medications. A moment of interruption can result in serious personal injury.
- Do not over-reach. Keep proper footing and balance at all times. Proper footing and balance enables better control of the tool in unexpected situations.
- Always wear safety eye protection that meets ANSI standards.
- Do not wear loose clothing or jewelry. Keep your hair, clothing, and gloves away from moving parts. Loose clothes, jewelry, or long hair can be caught in moving parts.
- Do not place the tool on any unstable cart or surface. The tool may fall causing serious injury to a person or serious damage to the tool itself.
- Never spill liquid on the display units. Liquid increases the risk of electric shock and damage to the tool.
- Do not use the tool for personal or medical use in any way.
- The product is not shock-resistant. Do not use it as a hammer or drop it.

Contents

1	USING THE MANUAL.....	1
	CONVENTIONS.....	1
2	GENERAL INTRODUCTION.....	3
	MAXIVIDEO MV500 DISPLAY TABLET.....	3
	HANDLE, CABLE AND IMAGER HEADS.....	7
	ACCESSORIES INCLUDED.....	11
3	INSTALLATION AND CONNECTION.....	12
	THE DISPLAY TABLET AND HANDLE CONNECTION.....	12
	THE IMAGER HEADS AND CABLE INSTALLATION.....	12
	ACCESSORIES INSTALLATION.....	13
	MICRO SD CARD INSTALLATION.....	13
	MINI USB CABLE CONNECTION.....	14
	HDMI CABLE CONNECTION.....	14
4	BATTERY CHARGING PRECAUTIONS.....	15
	BATTERY CHARGING SAFETY.....	15
	BATTERY AND CHARGER SPECIFICATIONS.....	15
	CHARGER INSPECTION.....	16
	BATTERY CHARGING PROCEDURES.....	17
5	OPERATION INSTRUCTIONS.....	18
	NAVIGATION.....	18
	BASIC OPERATION.....	21
	OPERATION PRECAUTIONS.....	25
	TOOL INSPECTION.....	27
	TOOL AND WORK AREA SET-UP.....	28
6	SETTINGS.....	30
	Wi-Fi.....	30
	COLOR MODE.....	32
	DATE AND TIME.....	33

SCREEN BRIGHTNESS	34
SOUND	35
LANGUAGE	36
STORAGE LOCATION	37
SCHEDULED POWER-OFF	38
SERIAL NUMBER	39
FORMAT	39
RESTORE FACTORY SETTINGS	40
VERSION	41
UPDATE	42
7 TROUBLESHOOTING	46
8 COMPLIANCE INFORMATION	47
9 WARRANTY AND SERVICE	49
LIMITED ONE YEAR WARRANTY.....	49
SERVICE INFORMATION	50

1 Using the Manual

This manual contains device usage instructions.

Some illustrations shown in this manual may contain modules and optional equipment that are not included on your system. Contact your sales representative for availability of other modules and optional tools or accessories.

Conventions

The following conventions are used.

Bold Text

Bold text is used to highlight selectable items such as buttons and menu options.

Example:

- Tap **OK**.

Notes and Important Messages

Notes

A **NOTE** provides helpful information such as additional explanations, tips, and comments.

Example:

NOTE

New batteries reach full capacity after approximately 3 to 5 charging and discharging cycles.

Important

IMPORTANT indicates a situation which, if not avoided, may result in damage to the test equipment or vehicle.

Example:

! IMPORTANT

Keep the cable away from heat, oil, sharp edges and moving parts. Replace damaged cables immediately.

Hyperlinks

Hyperlinks or links that take you to other related articles, procedures, and illustrations are available in electronic documents. Blue italic text indicates a selectable hyperlink.

Procedures

An arrow icon indicates a procedure.

Example:

➤ To adjust the sound

1. Tap the **Settings** icon on the live image screen.
2. Tap the **Sound** option on the column.
3. Slide the **Sound** icon left or right on the sound indicator bar for different volume. The righter the icon is, the louder the sound would be.
4. Tap **Save** on the top right corner to confirm and return to Settings menu.

Illustrations

Illustrations used in this manual are samples, the actual testing screen may vary for each vehicle being tested. Observe the menu titles and on-screen instructions to make correct option selection.

2 General Introduction

MaxiVideo MV500 is Autel's most advanced digital inspection camera to date. Its revolutionary tablet design supports wireless image transmission of up to 30 meters between the MaxiVideo MV500 display tablet and inspection scope. Along with its dual-camera cable, MaxiVideo MV500 gives technicians the freedom to work either individually or collaboratively during inspection to produce best results.

This manual describes the construction and operation of the device and how it works to examine difficult-to-reach areas.

MaxiVideo MV500 Display Tablet

Functional Description

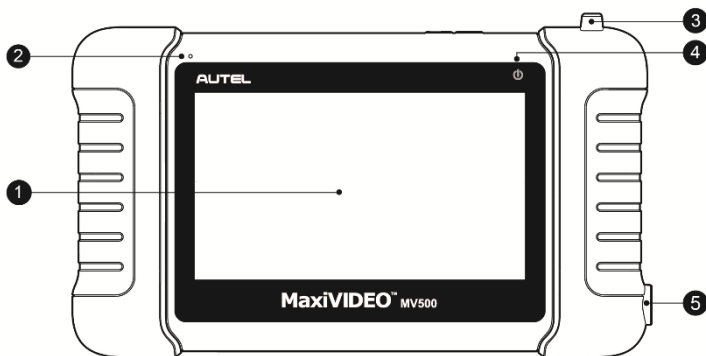

Figure 2-1 MaxiVideo MV500 Display Tablet Front View

1. 5.0" LCD Capacitive Touchscreen
2. Microphone
3. Rubber Protrusion – helps to hold the MV500 handle to the display tablet.
4. Power LED Light – indicates battery level & charging status.

5. Round-shaped Magnet – attaches the MV500 handle with the display tablet.

The power LED light displays different colors in response to the following scenarios:

A. Green:

- Illuminates green when the display tablet is charging and the battery level is above 90%.
- Illuminates green when the display tablet is powered on and the battery level is above 15%.

B. Red:

- Illuminates red when the display tablet is powered on and the battery level is below 15%.

C. Yellow:

- Illuminates yellow when the display tablet is charging and the battery level is below 90%.

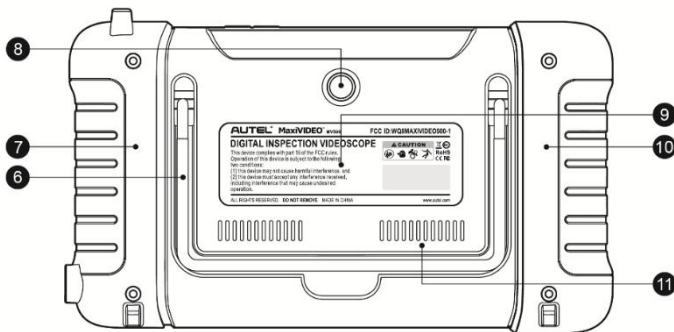

Figure 2-2 MaxiVideo MV500 Display Tablet Back View

6. Collapsible Stand – extends from the back at 30/60/90 degree angles to allow hands-free viewing of the display tablet.
7. Built-in Magnet (left)
8. Rear Camera
9. Built-in Battery

10. Built-in Magnet (right)
11. Loudspeaker

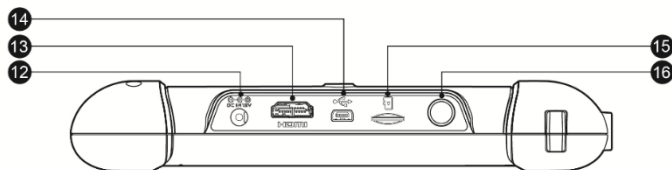

Figure 2-3 MaxiVideo MV500 Display Tablet Top View

12. DC Power Supply Input Port – connects the 5 volt power adapter to charge.
13. HDMI Port
14. Mini USB Port
15. SD Card Slot
16. Lock/Power Button – turns the device on & off with long press (Power off, Reboot, Airplane mode, Silent mode), or locks the screen with short press.

Power Sources

The display tablet can receive power from any of the following sources:

- Internal Battery Pack
- DC Power Supply

Internal Battery Pack

The display tablet can be powered with the internal rechargeable battery, which if fully charged can provide sufficient power for about 3.5 hours of continuous operation.

DC Power Supply

The display tablet can be powered from a wall socket using the DC power adapter. The DC power supply also charges the internal battery pack.

Technical Specifications

Table 2-1 *Display Tablet Specifications*

Item	Description
Recommended Use	Indoor
Operating System	Android™ 4.4.2, KitKat
Processor	RockChip RK3188 Cortex-A9 quad-core processor (1.6 GHz)
Memory	1GB RAM DDR3 & 16GB ROM
Display	5-inch LCD capacitive touchscreen with 1280x720 resolution
Dimensions	195.2 x 115.6 x 32.4 mm (7.7" x 4.6" x 1.3")
Connectivity	Mini USB 2.0 HDMI Type A SD card (supports up to 32GB)
Wi-Fi	802.11 b/g/n
Camera	Rear-facing, 5-megapixel
Sensor	Gravity accelerometer
Audio Input/Output	Microphone Single speaker
Power and Battery	3.7 V/3200 mAh lithium-polymer battery Charges via 5 VDC power supply
Tested Battery Life	Around 3.5 hours of continuous use
Battery Charging Input	5 V/3 A
Power Consumption	3 W
Operating Temp.	0°C to 50°C (32°F to 122°F)

Item	Description
Storage Temp.	-20°C to 70°C (-4°F to 158°F)
Operating Humidity	5% - 95% non-condensing
Housing	Strong plastic housing with protective rubber boot
Net Weight	463 g (1.02 lb.)

Handle, Cable and Imager Heads

Functional Description

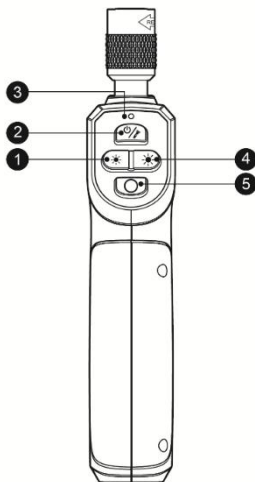

Figure 2-4 MaxiVideo MV500 Handle Front View

1. LED Light Dimmer Button –decreases LED light brightness.
2. Power Button – turns on/off the tool with long press, or turns on/off the flashlight with short press.
3. Power LED Light – indicates battery level & charging status.

The power LED light displays different colors in response to the following scenarios:

- A. Green:
 - Illuminates green when the MV500 handle is charging and the battery level is above 90%.
 - Illuminates green when the MV500 handle is powered on and the battery level is above 15%.
 - B. Red:
 - Illuminates red when the MV500 handle is powered on and the battery level is below 15%.
 - C. Yellow:
 - Illuminates yellow when the MV500 handle is charging and the battery level is below 90%.
4. LED Light Brighter Button –increases LED light brightness.
 5. Shutter Button – starts capturing image or video.

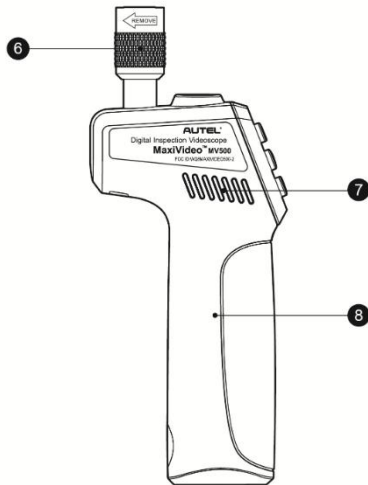

Figure 2-5 MaxiVideo MV500 Handle Left Side View

6. Knurled knob
7. Heat sink
8. Built-in Battery

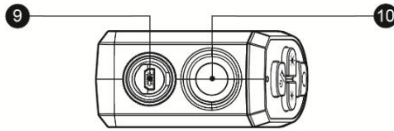

Figure 2-6 MaxiVideo MV 500 Handle Top View

- 9. USB Port
- 10. Flashlight

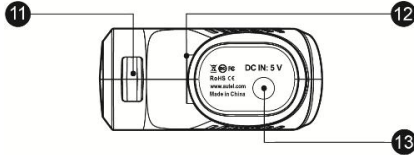

Figure 2-7 MaxiVideo MV500 Handle Bottom View

- 11. Rabbet
- 12. Round-shaped Rabbet
- 13. Power Supply Input Port – connects the 5 volt power adapter to charge.

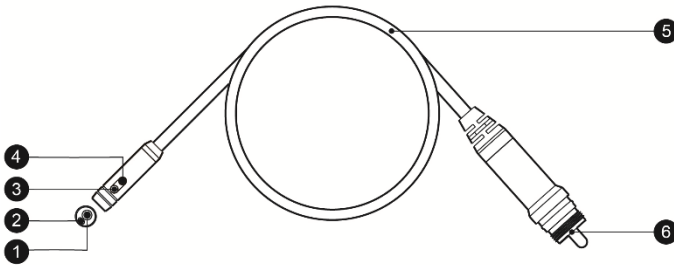

Figure 2-8 MaxiVideo MV500 Cable and Imager Heads

- 1. Front Imager Head
- 2. Front LED Light
- 3. Side LED Light
- 4. Side Imager Head
- 5. Cable
- 6. USB Plug

Power Sources

The handle can receive power from any of the following sources:

- Internal Battery Pack
- DC Power Supply

Internal Battery Pack

The handle can be powered with the internal rechargeable battery, which if fully charged can provide sufficient power for about 2.8 hours of continuous operation.

DC Power Supply

The handle can be powered from a wall socket using the DC power adapter. The DC power supply also charges the internal battery pack.

Technical Specifications

Table 2-2 *MV500 Handle Specifications*

Item	Description
Recommended Use	Indoor
Processor	Grain GM8287 processor (792 MHz ARM-based 32-bit RISC)
Memory	256MB RAM & 16MB ROM
Optimal Viewing Distance	2.5 cm to 35.6 cm (1" to 14")
Dimensions	180.2 x 73.8 x 33.6 mm (7.1" x 2.9" x 1.3")
Power Supply	Built-in rechargeable lithium-ion battery pack (3.7 V/2600 mAh)
Tested Battery Life	Around 2.8 hours of continuous use
Battery Charging Input	5 V/3 A

Item	Description
Image Capture	JPG images (1280 x 720) H.264 videos (1280 x 720)
Image Controls	Zoom, low light vision
Lighting	Fully adjustable LED light 40 Lm (flashlight)
Cable Reach	1 m (39.4")
Imager Heads	8.5 mm (0.33"), about 1.0 megapixel (1280 x 720)
Waterproof	To a depth of 1.6 m (63") (imager heads and cable)
Additional Port	Mini USB – 10 Pin
Power Consumption	3 W
Operating Temp.	Handle & cable: 0°C to 60°C (32°F to 140°F)
Storage Temp.	Handle & cable: -20°C to 70°C (-4°F to 158°F)
Operating Humidity	5% - 95% non-condensing
Wi-Fi	802.11 b/g/n
Net Weight	290 g (0.64 lb.)

Accessories Included

- 1) User Manual
- 2) Imager Heads and Cable (8.5 mm)
- 3) Magnet and Hook
- 4) Charger
- 5) Mini USB Cable
- 6) HDMI Cable
- 7) Protective Carrying Case

3 Installation and Connection

The Display Tablet and Handle Connection

To connect the display tablet and handle, insert the rubber protrusion on the top right of the display tablet into the corresponding rabbet on the back of the handle and the round-shaped magnet on the right bottom of the display tablet into the corresponding round rabbet on the back of the handle (Fig 3-1). Make sure they are properly aligned for firm connection.

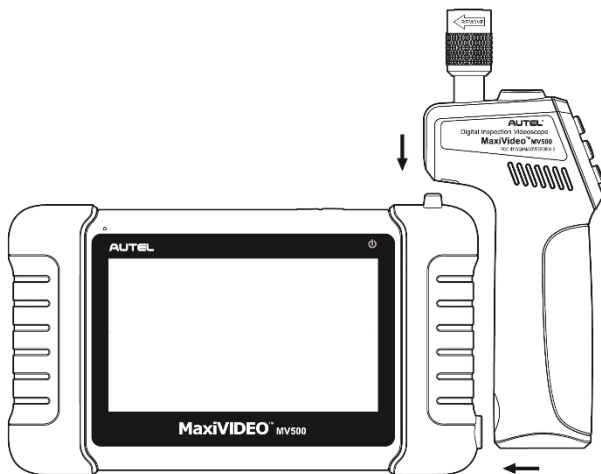

Figure 3-1

The Imager Heads and Cable Installation

To use the tool, the imager heads and cable must be connected to the handle. To connect the cable to the handle, make sure the key and slot (Fig 3-2) are properly aligned. Once they are aligned, finger-tighten the knurled knob to hold the connection firmly in place.

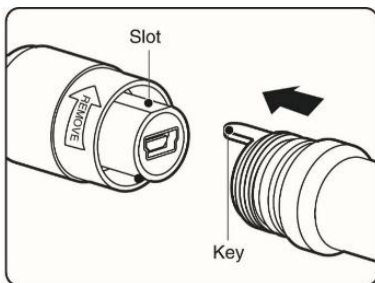

Figure 3-2

Accessories Installation

The two accessories include one magnet and one hook (Fig 3-3). Both are attached to the imager head in the same manner. Hold the accessory and the imager head as shown in Fig 3-4. Slip the end of the accessory over the imager head and then fix the accessory as shown in Fig 3-5.

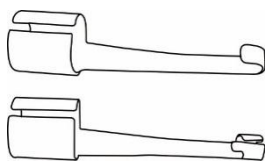

Figure 3-3 Accessories

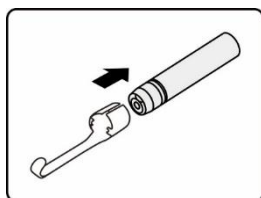

Figure 3-4

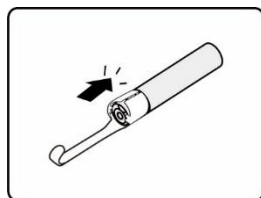

Figure 3-5

Micro SD Card Installation

To insert a Micro SD card into the Micro SD card slot, make sure the pins are facing away from the screen. To remove the Micro SD card, gently push the Micro SD card inward and then release to eject it from the card slot.

NOTE

Micro SD card slot provides for additional memory, but Micro SD card is optional and not included. Different Micro SD cards can be used to insert into the Micro SD card slot. The maximum 32GB of the Micro SD card can be supported.

Mini USB Cable Connection

Use the supplied mini USB cable to connect the tool to a PC to upload and view captured photos and videos. When the display tablet is successfully connected to the PC, a small window will pop up on the screen of the PC to allow you to manage the photos and videos stored in the display tablet. You would also find a file named as “MV500” in the PC’s Portable Devices or Others section.

HDMI Cable Connection

Insert the HDMI cable into the HDMI port of the tool and the other end of the cable into the HDMI port of a TV, the LCD screen will output a high quality real-time image.

4 Battery Charging Precautions

To reduce the risk of serious injury, read these precautions and the label on charger's surface carefully before using.

Battery Charging Safety

- Do not probe charger with conductive objects.
- Do not use charger if it has been dropped or damaged in any way.
- Charge battery between 10°C (50°F) and 45°C (113°F).
- When in use, the charger shall be kept out of heat, high voltage and avoid children's touching.
- Use the supplied charger. Do not charge the battery over 24 hours.
- Do not cover the charger while in use.
- Unplug the charger from outlet before attempting any maintenance or cleaning.
- Do not store charger in damp, wet or explosive environment.
- Do not open charger housing. Have repairs performed only at authorized locations.
- Do not charge battery near fire or in the sunlight.
- Proper care will prevent serious damage to the charger.

Battery and Charger Specifications

Table 4-1 Specifications

Item	Description
Charger Input	100-240 VAC, 50/60 Hz
Charger Output	5 VDC

Item	Description
Battery Type	3.7 V lithium-ion
Battery Capacity	3200 mAh (display tablet) 2600 mAh (handle)
Charging Time	3 hours (display tablet) 2.8 hours (handle)
Cooling	Active fan cooling Fan (1.8 CFM, 0.05 CMM)

Charger Inspection

Before using, inspect the charger and fix any problems. Set up charger according to these procedures to reduce the risk of injury from electric shock, fire and other causes and prevent tool damage.

1. Make sure charger is unplugged. Inspect the power cord and charger for damage or broken, worn, missing, misaligned, binding parts. If any problems are found, do not use the charger until the parts have been repaired or replaced.
2. Clean any oil, grease or dirt from the tool especially on the buttons. This helps to prevent the tool from slipping from your hands and allows proper ventilation.
3. Inspect if the warning label on charger's surface is intact and readable.
4. Select appropriate location for charger before using. Check work area for:
 - The charger must be between 10°C (50°F) and 45°C (113°F) for charging. If the temperature of either is outside of this range at any point during charging, the operation will be suspended until the charger is brought back to the correct temperature range.
 - Inspect that the plug fits correctly into the desired outlet.
 - The charger needs a clearance of at least 10 cm (4") on all sides to maintain a proper operating temperature.

Battery Charging Procedures

The MV500 has two 3.7 V built-in lithium-ion rechargeable batteries, a 3200 mAh lithium-ion battery for the display tablet and a 2600 mAh lithium-ion battery for the handle. When the battery level is below 15% and the tool is not charging, the corresponding Battery Capacity icon on the top of the display tablet screen will be red until the tool shut down automatically.

For both of the batteries, they can only be charged by charger:

- To charge by charger:
 - Locate the DC power source port of the tool.
 - With dry hands, connect the tool to the outlet with charger to start charging.

NOTE

New batteries reach full capacity after approximately 3 to 5 charging and discharging cycles.









5 Operation Instructions

















Always wear safety eye protection to protect your eyes against dirt and other objects. Follow operation instructions to reduce the risk of injury from electric shock, entanglement and other causes.







Navigation

In the MV500 display tablet system, each screen contains a number of icons that allow you to make desired selections and controls. The table below provides a brief description of the operations of the icons in the system.

Table 5-1 *Icons*

Name	Icon	Description
Rear Camera		Tap this icon to display different camera modes or choose rear camera mode.
Front Camera		Tap this icon for front camera mode.
Side Camera		Tap this icon for side camera mode.
Dual Camera		Tap this icon for dual camera mode.
Rotate (main)		Tap this icon to rotate the main window by 90° clockwise in dual camera mode.
Rotate (small)		Tap this icon to rotate the secondary window by 90° clockwise in dual camera mode.
Rotate		Tap this icon to rotate the live image screen by 90° clockwise in rear camera mode, front camera mode, and side camera mode.
Settings		Tap this icon to open the setting screen to set Wi-Fi, Color Mode, Date & Time, etc.

Name	Icon	Description
Shutter		Tap this icon to take photos.
Start		Tap this icon to begin video shooting.
Stop		Tap this icon to stop video shooting or message recording.
Video/Camera		Tap this icon to switch between still image and video mode.
Back		Tap this icon to return to the previous screen.
Dropdown		Tap this icon to show all the items in the list.
Collapse		Tap this icon to hide all the items in the list.
Handle Battery		Indicates the battery level of the handle.
Display Tablet Battery		Indicates the battery level of the display tablet.
Edit		Tap this icon to edit the image.
Record		Tap this icon to record an audio message for an image.
Play		Tap this icon to play the exiting audio message of an image.
Delete		Tap this icon to delete the selected items.
Cancel		Tap this icon to exit without saving the made marks.
Save		Tap this icon to exit and save all the made marks.
Freestyle Marks		Tap this icon to make freestyle marks on the selected picture.
Arrow		Tap this icon to make arrows on the selected picture.

Name	Icon	Description
Circle		Tap this icon to circle desired areas on the picture.
Square		Tap this icon to square desired areas on the picture.
Color		Tap this icon to choose different colors for the marks.
Undo		Tap this icon to undo the previous marks one by one.
Restore		Tap this icon to restore the deleted marks one by one.
Recording		Indicates the audio message is being recorded.

Splash Screen

When the tool is powered on, the first screen displayed is referred to as the splash screen (Fig 5-1). This screen tells you the tool is booting up. Once the tool is fully powered up, the screen will automatically switch to the live screen.



Figure 5-1 *Sample Splash Screen*

Live Screen

The live screen is where you can do most of your work. By default, a live

image of what the rear camera sees is displayed on the screen. You can zoom, rotate images and videos, view and capture photos and videos from this screen.

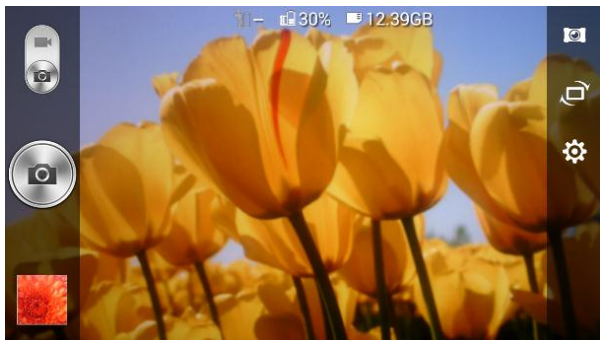

Figure 5-2 Sample Live Screen

Basic Operation

NOTE

When in operation, the cable can be bent into a certain shape. This may help you operate the cable into confined areas.

IMPORTANT

Keep the cable away from heat, oil, sharp edges and moving parts. Replace damaged cables immediately.

Getting Started

- 1) To turn the tool on, hold the display tablet with LCD screen facing you. Long press the **Power** button to turn it on. The power LED light will illuminate green. Wait for two seconds, the first screen – a splash screen will boot up and then a live screen with real-time image will appear for you to do most of your work.
- 2) Long press the **Power** button of the handle to turn it on.
- 3) To connect the display tablet with the handle via Wi-Fi.
 - A. Tap the **Settings** icon on the right side of the LCD screen.
 - B. Tap **Wi-Fi** and turn it on.

- C. Tap handle Wi-Fi in the list of **Wi-Fi of the MV500 handle**, then it would automatically connect. The Wi-Fi name of the handle is on the right side label. Only one handle can be connected for use at one time.
- D. Tap **Save** on the top right of the screen to go back to the previous screen.

Live Image Management

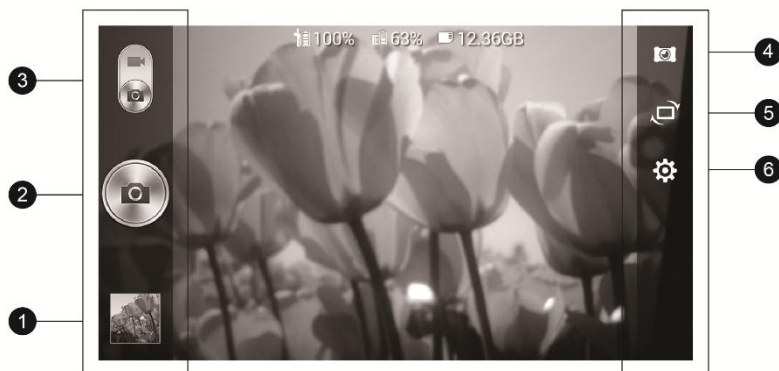

- | | |
|----------------|---------------|
| ① Playback | ④ Rear Camera |
| ② Shutter | ⑤ Rotate |
| ③ Video/Camera | ⑥ Settings |

① *Playback*

This icon displays the most recent photo/video taken. You may tap it to view photos and videos in **Built-in Storage** and **External Storage**, or edit and delete your photos and videos one by one or in groups.

When viewing the pictures, you can edit, record audio message, zoom and roll, below is the detailed instruction for each operation.

➤ Picture Editing

Tap the **Edit** icon on the top right of the screen to go to editing interface which allows you to make marks on the images captured.

- Freestyle Marks – tap the **Freestyle Marks** icon on the top and then use your finger to make marks on the picture.
- Arrow – tap the **Arrow** icon on the top and then use your finger to slide on the screen to make arrows.
- Circle – tap the **Circle** icon on the top and then use your finger to slide on the screen to make different sizes of circles.
- Square – tap the **Square** icon on the top and slide on the screen to make different sizes of square or rectangle.
- Color – tap the **Color** icon on the top to choose from the six colors (black, white, blue, green, yellow, and red) for the marks. By default the tool uses yellow.
- Save – tap the green ✓ to save all made marks.
- Cancel – tap the red ✕ to cancel all made marks.

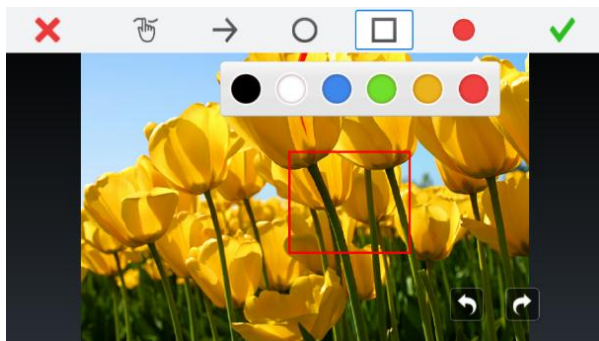

Figure 5-3 *Sample Editing Screen*

➤ Audio Message Recording

Tap the **Record** icon on the top right of the screen to record an audio message for the picture and tap the **Stop** icon to end the recording.

For a picture with an audio message, tap the **Play** icon on the top right of the screen to play the existing audio message. Tap the **Delete** icon on the top right of the screen and choose **Delete Recording** to delete the recorded audio message.



Figure 5-4 *Sample Audio Recording Screen*

➤ **Zoom**

Double click the screen to zoom in or out the picture when viewing. Or two-finger press the screen to pinch open or pinch close for zooming in and zooming out.

➤ **Roll**

Finger slide left or right for picture viewing.

② **Shutter**

Tap this button or press **OK** button on the handle to capture a photo in any camera mode or begin capturing video in video mode. Simultaneously the photo or video will be saved to built-in storage or external storage (if SD card is available) depending on the storage setting.

🔗 **NOTE**

For dual camera mode, only live image/video on the main window can be captured, but you can switch live images/videos of the two cameras then capture the one you want.

③ **Video/Camera**

Tap this button to switch between still image and video modes.

④ **Rear Camera**

Tap this button to choose displayed camera modes. There are four modes.

They are front camera, side camera, dual camera, rear camera from left to right. For the dual camera mode, tap the secondary window on the right bottom to switch live images of the two cameras on the main window for better view.

⑤ *Rotate*

Tap this button to control the direction of the real-time image. The real-time image will do a 90° clockwise rotation for each tap of the icon. In dual camera mode, there is a main **Rotate** icon for the main window and a small **Rotate** icon for the secondary window so that you can choose to rotate the image you want by tapping the corresponding **Rotate** icon.

⑥ *Settings*

Tap this button to entering the setting interface. See [chapter 6](#) for details.

Adjusting LED Light Brightness

To adjust the two LEDs' light intensity on the cable, press the **Dimmer** button or the **Brighter** button on the handle to decrease or increase the brightness. This can also be achieved by tapping the middle of the LCD screen and sliding the two **LED Light** icons on the two brightness indicator bars with the left one for the front camera and the right for the side camera. The higher the icon is, the brighter the LED will be.

Operation Precautions

- Use the tool only as directed. Do not operate the tool unless the user manual has been read thoroughly and proper training has been completed.
- The display unit is not waterproof. The imager heads and cable are waterproof, but not acid-proof or fireproof. Avoid submersing the imager heads and cable into corrosive, oily places and be sure to keep the imager heads and cable away from high temperature objects.
- Do not immerse the tool and display unit in water. Such measures increase the risk of electric shock and damage.

- Do not use excessive force to insert or withdraw the imager heads and cable. This may result in damage to the tool or inspection area.
- Do not use the imager heads and cable to modify surroundings, clear pathways or clogged areas.
- Do not place the imager heads and cable into anything or anywhere that may contain a live electric charge or moving parts, which increases the risk of electric shock or entanglement injuries.
- Do not use the tool for personal inspection or medical use in any way. This is not a medical tool.
- Do not eat or smoke while operating the tool. Use warm, soapy water to wash hands and other body parts exposed to drain contents after using the tool to inspect drains and other areas that may contain chemicals or bacteria, which will help prevent contamination with toxic or infectious material.
- When the inspection is completed, carefully withdraw the imager heads and cable from inspection area.
- Store idle components out of the reach of children and other untrained persons.
- Maintain the tool with care. Properly maintained tools are less likely to cause injury.
- Do not drop the tool, if the tool is dropped accidentally, check for the breakage and any other conditions that may affect its operation.
- Use only accessories that are recommended by the manufacturer for the tool.
- Dry your hands when operating the tool or charging the battery.
- Always use appropriate personal protective equipment while handling and using the tool. Appropriate personal protective equipment usually includes safety glasses and gloves, and may include latex or rubber gloves, face shields, goggles, protective clothing, respirators and steel toed footwear.
- Protect against excessive heat. The tool should be kept away from heat sources such as radiators, stoves or others that produce heat. Do not use the tool near moving machinery or areas where the temperature will exceed 45°C (113°F).

- Store the tool, charger and all cables in a locked area out of the reach of children and people unfamiliar with the tool.

Tool Inspection

Before using, inspect your tool and correct any problems to reduce the risk of serious injury from electric shock and other causes and prevent tool damage.

- Make sure the power is OFF.
- Clean any oil, grease or dirt from the tool, especially on the buttons and ports. This helps prevent the tool from slipping from your hands.
- Inspect the imager head lens for condensation. To avoid damaging the tool, do not use the tool if condensation forms inside the imager heads. Let the water evaporate before using again.
- Inspect the full length of the cable for cracks or damage. A damaged cable could allow water to enter the tool and increase the risk of electric shock.
- Make sure the connections between the display unit and imager heads and cable are tight. All connections must be properly assembled for the cable to be waterproof.
- Check if the warning label is present, firmly attached and readable. Do not operate the tool without caution label.
- If the tool does not work well after being turned on, please have the tool checked by a qualified technician. Any tool that cannot be controlled with the power button is dangerous and must be repaired.

NOTE

Please follow these tips to avoid injury.

- ✓ **FOR WALLS:** For inspecting the inside of walls, be sure to shut off the circuit breaker of the whole house before using the tool.
- ✓ **FOR PIPES:** If you suspect a metal pipe could contain an electric charge, have a qualified electrician check the pipe before using.
- ✓ **FOR AUTOMOBILES:** Be sure the automobile is not running during inspection. Metal and liquid under the hood may be hot. Don't get oil or gas on the imager heads.

Tool and Work Area Set-up

Set up the tool and work area according to these procedures to reduce the risk of injury from electric shock, entanglement, and other causes and prevent tool damage.

- 1) Check work area for:
 - ✓ Sufficient lighting.
 - ✓ Do not work in area until flammable sources have been identified and corrected. The tool is not explosion proof and can cause sparks.
 - ✓ Do not use the tool while standing in water.
- 2) Check the area and determine if MaxiVideo™ MV500 Digital Inspection Videoscope is the correct tool for the job.
 - ✓ Check the access to the area.
 - ✓ Check if there is any electric power supplied to the area to be inspected.
 - ✓ Check if any liquid would occur during the inspection. The Imager heads and cable are waterproof to a depth of 1 m (39.4"), greater depths may cause leakage into the imager heads and cable and cause electric shock or damage the tool. The display unit is not waterproof and should not be exposed to wet conditions.
 - ✓ Check if any chemicals are present, especially in the case of drains. Chemicals may damage the tool.
 - ✓ Check the temperature of the area. The working temperature of the tool is between 0°C (32°F) and 45°C (113°F).
 - ✓ Check if any moving parts are present in the area.
- 3) Make sure the tool has been properly inspected.
- 4) Install the correct accessories for use in the appropriate application.

! IMPORTANT

Make sure the tool has been powered off before performing maintenance.

- Tool maintenance must be performed only by qualified repair personnel. Maintenance performed by unqualified repair personnel could cause injury.

- When maintaining, use only identical replacement parts. Use of unauthorized parts or failure to follow maintenance instructions may create a risk of electric shock or injury.
- Do not attempt to take any pieces of the tool apart unless directed by the manual.
- Follow instructions to change accessories.
- Do not use acetone to clean the tool. Instead, use only alcohol to swab the connections. Avoid rubbing too hard on the LCD screen. After using, wipe the display unit clean gently with a dry cloth.
- Upon the completion of any maintenance of the tool, ask qualified repair personnel to perform safety checks to examine if the tool is in proper operating condition.
- Stop using the tool if it starts smoking or emitting noxious fumes.
- Always handle the tool with care. It is not shock-resistant.
- Do not disassemble the tool beyond what is shown in the manual, doing so will void your warranty.

6 Settings

Selecting Settings application opens a setup interface, on which you can adjust default setting and view information about the MV500 videoscope tool. There are fourteen options available for the MV500 system settings:

- **Wi-Fi**
- **Color Mode**
- **Channel**
- **Date and Time**
- **Screen Brightness**
- **Sound**
- **Language**
- **Storage Location**
- **Scheduled Power-off**
- **Serial Number**
- **Format**
- **Restore Factory Settings**
- **Version**
- **Upgrade**

Wi-Fi

This option allows you to connect the display tablet with the handle or the Internet.

➤ **To connect to the handle**

1. Tap the **Settings** icon on the live image screen.
2. Tap the **Wi-Fi** option on the column.
3. Tap the **On/Off** icon to turn the Wi-Fi on.

4. Tap handle Wi-Fi in the list of **Wi-Fi of the MV500 Handle** to connect. The Wi-Fi name of the handle is on the right side label. Only one handle can be connected for use at one time.
5. Tap **Save** on the top right corner or the **Back** arrow on the top left corner to confirm and return to the Settings menu.

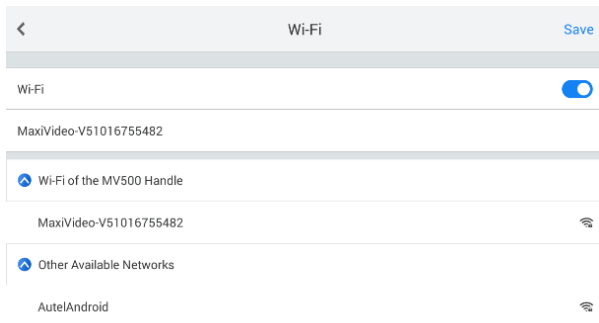

Figure 6-1 *Sample Handle Wi-Fi Connection*

! IMPORTANT

Each Autel MV500 handle communicates with one MV500 display tablet at one time. Once connected for the first time, they will automatically connect next time in use.

➤ **To connect to the Internet**

1. Follow the 1-3 steps in **To connect to the handle**.
2. Tap **Other Available Networks** to select the Wi-Fi and input the password in the **Password** blank when required. A typing screen will show after a tap at the blank. You can choose to show password by tapping the square box in front of **Show password**.
3. Tap **Connect** to confirm or **Cancel**.
4. Tap **Save** on the top right corner or the **Back** arrow on the top left corner to confirm and return to the Settings menu.

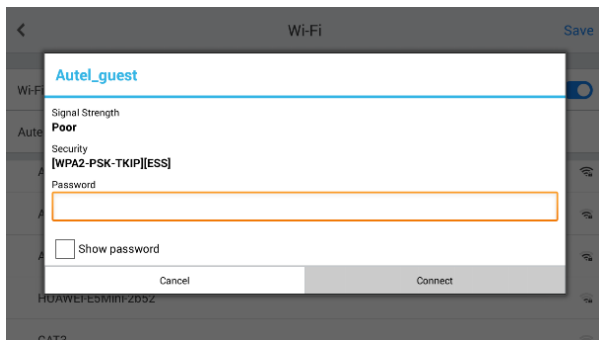

Figure 6-2 Sample Internet Connection

Color Mode

This option allows you to choose between Color mode and Gray mode for the two cameras on the cable.

➤ **To choose the color mode**

1. Tap the **Settings** icon on the live image screen.
2. Tap the **Color/Gray** icon to choose the mode you want. The pane of the selected mode will be colored blue with the word in white.
3. Tap **Save** on the top right corner or the **Back** arrow on the top left corner to confirm and return to the live image screen.

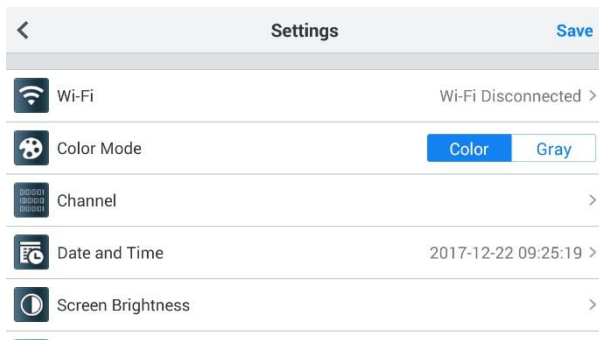

Figure 6-3 Sample Color Mode Setting

NOTE

The Color/Gray mode only applies for the two cameras on the cable, not for the rear camera on the display tablet. It would not work in rear camera mode. Color is the default mode.

Channel

This option allows you to adjust the channel for Wi-Fi transmission. If the Wi-Fi transmission is affected in strong interference environments, you can select another Wi-Fi channel for better transmission.

➤ **To choose a channel**

1. Tap the **Settings** icon on the live image screen.
2. Tap the **Channel** option on the column.
3. Select the desired channel and tap **OK** to save and exit.

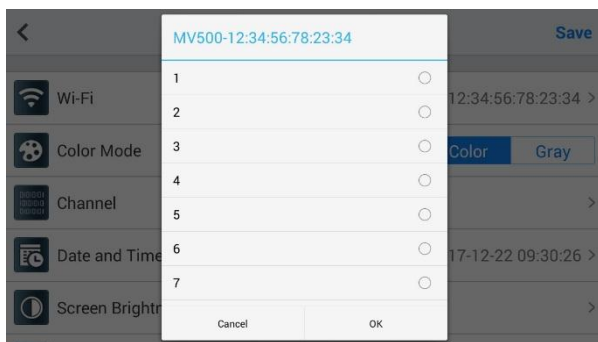

Figure 6-4 *Sample Channel Setting*

Date and Time

This option allows you to adjust the date and time for the MV500 system.

➤ **To adjust the Date and Time setting**

1. Tap the **Settings** icon on the live image screen.
2. Tap the **Date and Time** option on the column.

3. To set date and time automatically, tap the box on the right of **Set Automatically**, a tick will show afterwards. Please be noted that connection to the Internet is necessary for this option, otherwise a message “Please connect to the Internet to set date and time automatically” will pop up, tap **OK** to go to Wi-Fi setting or tap **Cancel** to quit this option.
4. To set date and time manually, roll up and down the digital bars for date and time. Please be noted that this option is only available when **Set Automatically** is not chosen, otherwise the digital bars would be locked and unable to be rolled.
5. Tap **Save** to confirm and return to Settings menu.

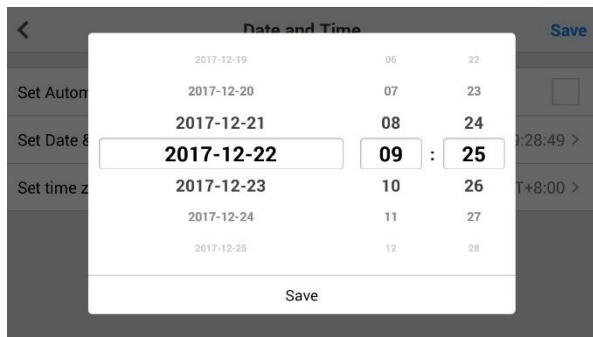

Figure 6-5 Sample Date and Time Setting

Screen Brightness

This option allows you to adjust brightness of the display screen.

➤ **To adjust screen brightness**

1. Tap the **Settings** icon on the live image screen.
2. Tap the **Screen Brightness** option on the column.
3. Slide the **Brightness** icon left or right on the brightness indicator bar for different level of screen brightness. The righter the icon is, the brighter the screen would be.

4. Tap **Save** on the top right corner to confirm and return to Settings menu.

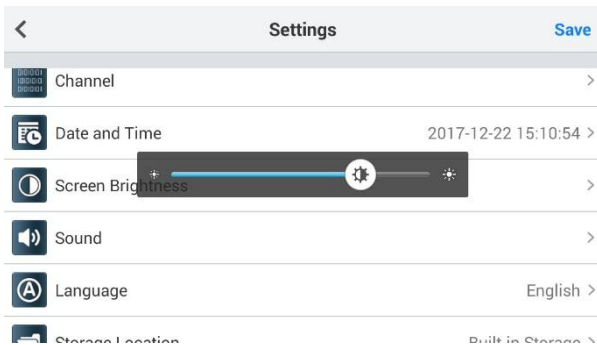

Figure 6-6 Sample Screen Brightness Setting

Sound

This option allows you to adjust the sound of the microphone.

➤ **To adjust the sound**

1. Tap the **Settings** icon on the live image screen.
2. Tap the **Sound** option on the column.
3. Slide the **Sound** icon left or right on the sound indicator bar for different volume. The righter the icon is, the louder the sound would be.
4. Tap **Save** on the top right corner to confirm and return to Settings

menu.

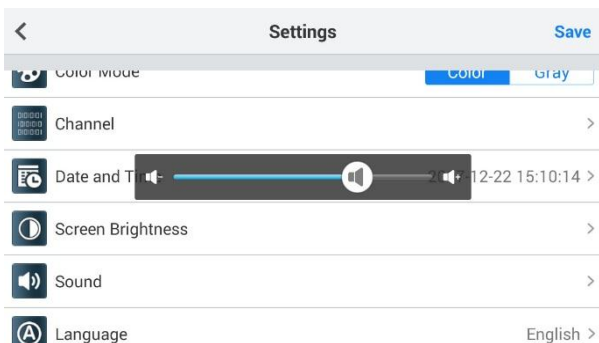

Figure 6-7 Sample Sound Setting

Language

This option allows you to select the display language for the MV500 system.

➤ **To select the language setting**

1. Tap the **Settings** icon on the live image screen.
2. Tap the **Language** option on the column.
3. Select the desired language and a tick icon will appear on the right of the selected language. English is the default language.

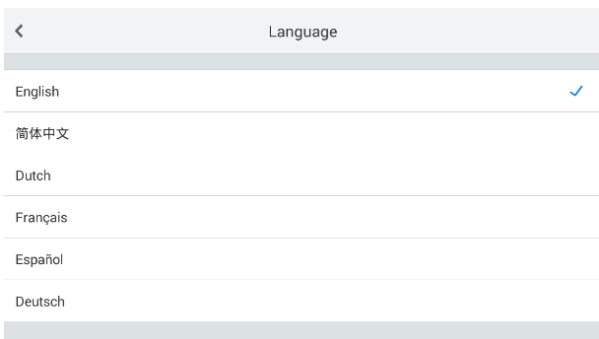

Figure 6-8 Sample Language Setting

NOTE

The screen will automatically return to the Primary Settings menu and display in the selected language after the selection.

Storage Location

This option allows you to choose the storage location of captured pictures and videos beforehand for the MV500 system.

➤ **To adjust the storage location setting**

1. Tap the **Settings** icon on the live image screen.
2. Tap the **Storage Location** option on the column.
3. Select the desired location. A tick will display to the right of the selected location.
4. Tap **Save** on the top right corner to confirm and return to Settings menu.

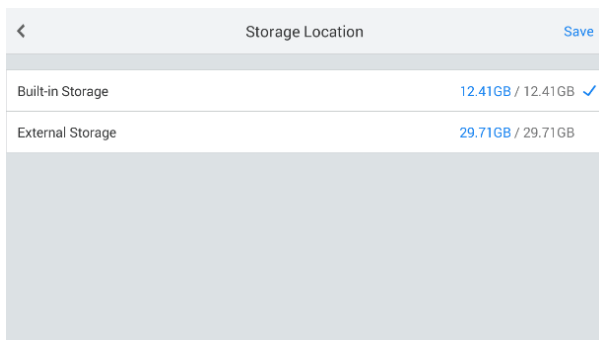

Figure 6-9 *Sample Storage Location Setting*

NOTE

External Storage is only available when a SD card is inserted into the SD card slot beforehand. And after the selection, captured pictures and videos will be automatically stored in the selected location all the time unless you change the location again.

Scheduled Power-off

This option allows you to schedule an automatic power-off in a certain time for the display tablet.

➤ **To adjust the scheduled power-off setting**

1. Tap the **Settings** icon on the live image screen.
2. Tap the **Scheduled Power-off** option on the column.

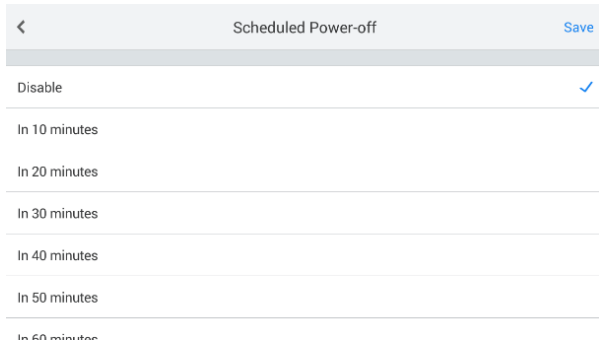

Figure 6-10 *Sample Scheduled Power-off Setting*

3. Select one of the 7 choices: Disable, In 10 minutes, In 20 minutes, In 30 minutes, In 40 minutes, In 50 minutes, In 60 minutes. A tick will display to the right of the selected time. Manual time setting is also available. You can tap **Set Time** and roll up and down in the setting screen then tap **OK** to confirm (Fig 6-10).
4. Tap **Save** on the top right corner to confirm and return to Settings menu.

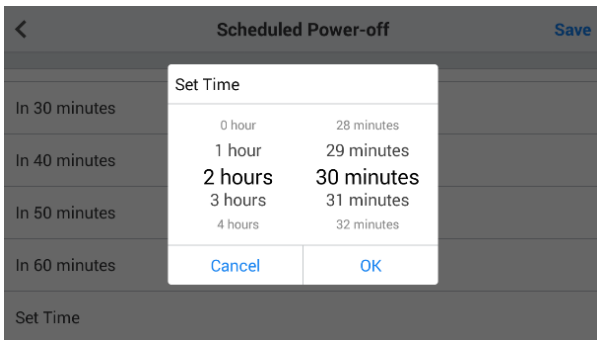

Figure 6-11 *Sample Set Time Screen*

Serial Number

This option shows the serial number of the MV500 display tablet.

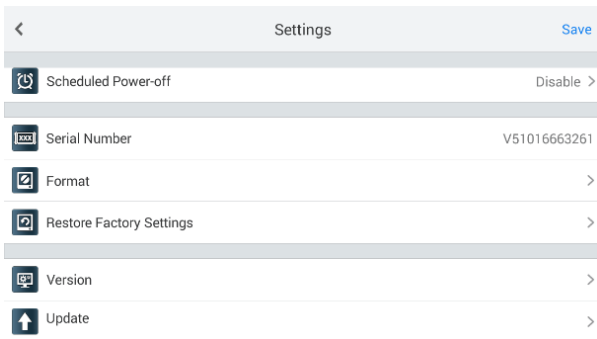

Figure 6-12 *Sample Serial Number Screen*

Format

This option allows you to format SD card.

➤ **To adjust the format setting**

1. Tap the **Settings** icon on the live image screen.
2. Tap the **Format** option on the column.

3. Tap **OK** in the confirm screen to start formatting, or tap **Cancel** to quit formatting. When formatting is finished, it will take you back to the primary settings screen. Please be noted that SD card content cannot be restored after formatting.

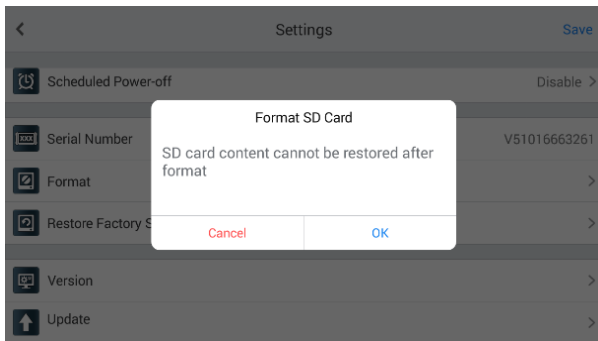

Figure 6-13 Sample Format SD Card Setting

NOTE

Before performing the formatting, make sure you have viewed the files in the SD card thoroughly.

Restore Factory Settings

This option allows you to reset all the settings.

➤ **To adjust the restore factory settings**

1. Tap the **Settings** icon on the live image screen.
2. Tap the **Restore Factory Settings** option on the column and a confirm screen will show.
3. Tap **OK** in the confirm screen, or **Cancel**. And the display tablet will reboot automatically after the restoration.

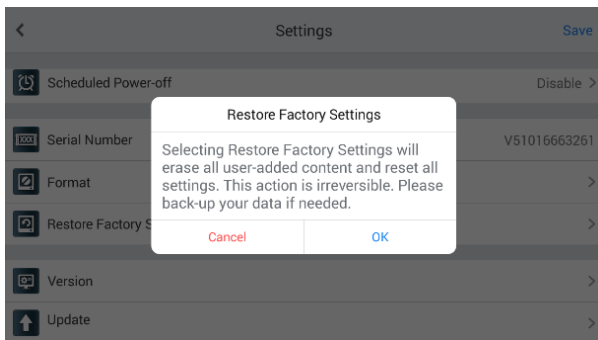

Figure 6-14 *Sample Restore Factory Settings*

NOTE

Selecting Restore Factory Settings will erase all user-added content and reset all settings. This action is irreversible. Please back-up your data if needed.

Version

This option shows you the information of the MV500 system. There are three items: Management Program Version, Handle System Version, and Display Tablet System Version.

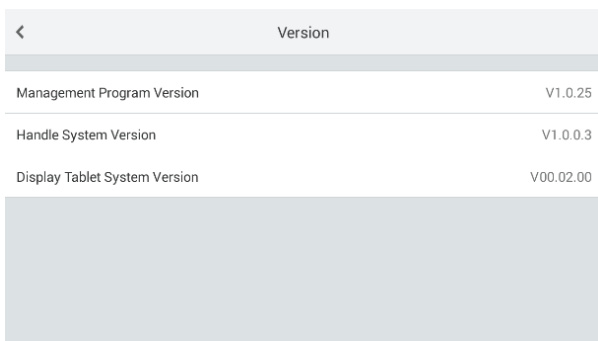

Figure 6-15 *Sample Version Screen*

NOTE

Handle System Version shows the system version information of the last handle that has connected to the display tablet or the handle that is connecting with the display tablet. If no handle had connected to the display tablet, “Connect to the Handle” will be displayed instead of the version information.

Update

Autel frequently releases software updates that you can download. This Update option allows you to check for the latest version of management program, handle system, display tablet system and update them. Connection to the Internet is necessary for this option.

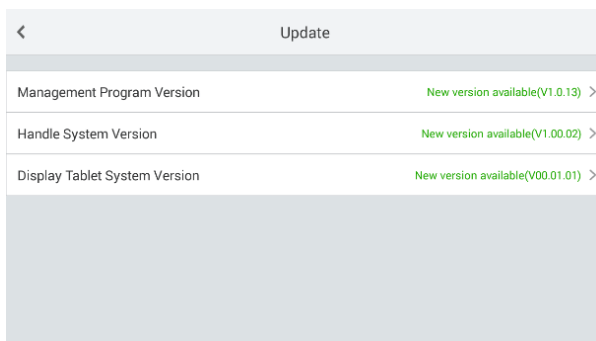

Figure 6-16 *Sample Upgrade Screen 1*

IMPORTANT

Please make sure the management program, handle system and display tablet system are updated to the latest version. Incompatible versions may result in malfunctioning of the tool.

If the display tablet is connected to the Internet, a window with management program, handle system and display tablet system version will pop up for you to update.

 **NOTE**

Handle System Version shows the system version information of the last handle that has connected to the display tablet or the handle that is connecting with the display tablet. If no handle had connected to the display tablet, Handle System Version would not be displayed. To update the handle system, please make sure the handle is connected with the display tablet.

If the display tablet is not connected to the Internet, a screen will direct you to network settings (Fig 6-16).

Tap **Head to network settings** and connect to the Internet. See **To connect to the Internet** in Wi-Fi on [page 32](#) for details.

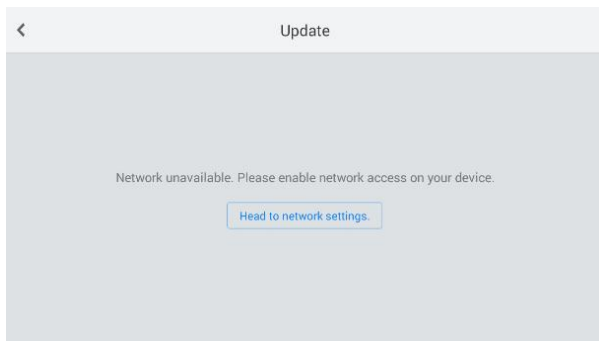

Figure 6-17 *Sample Upgrade Screen 2*

Management Program

1. Tap the **New version available** on the right side of **Management Program Version. Current version is the latest** means the version in use for management program is the latest, there is no need to update.
2. Tap **Download** in the download screen.
3. Tap **Install** after downloading to finish the installation. Then the tablet would automatically turn to live screen afterwards.

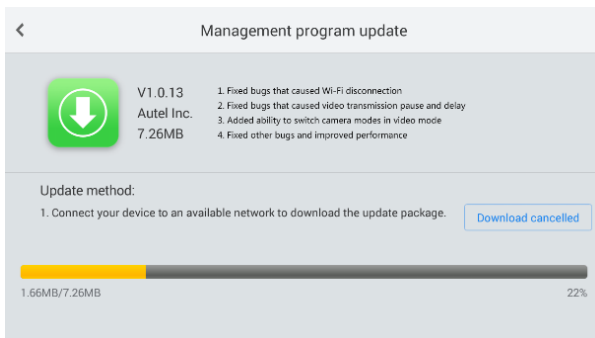

Figure 6-18 *Sample Management Program Update*

Handle System

1. Tap the **New version available** on the right side of **Handle System Version**. **Current version is the latest** means the version in use for the handle system is the latest, there is no need to update.
2. Tap **Download** in the download screen.
3. Tap **Install** after downloading. There would be a screen direct you to connect the display tablet with the handle Wi-Fi. Follow the on-screen navigation to connect. The display tablet will send the downloaded data to the MV500 handle for update, and the handle will automatically power off after the installation is finished.

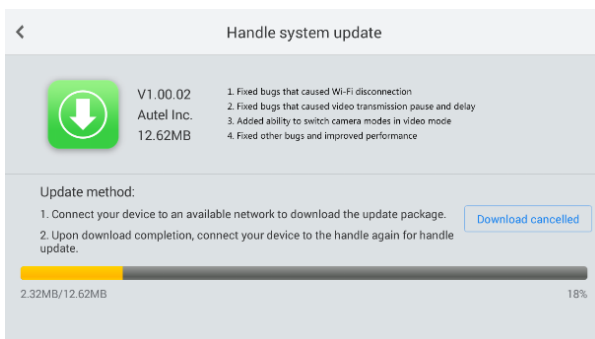

Figure 6-19 *Sample Handle System Update Screen 1*

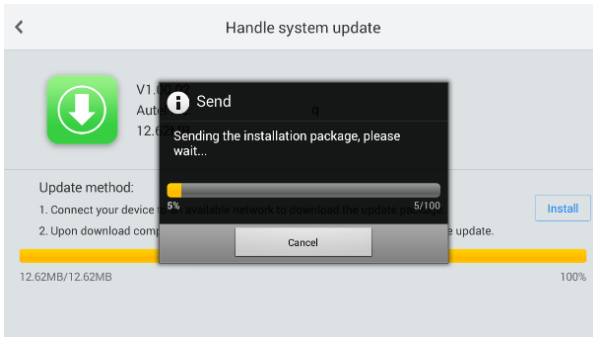

Figure 6-20 *Sample Handle System Update Screen 2*

Display Tablet System

1. Tap the **New version available** on the right side of **Display Tablet System Version. Current version is the latest** means the version in use for display tablet system is the latest, there is no need to update.
2. Tap **Download** in the download screen.
3. Tap **Install** after downloading to finish the installation. The display tablet will automatically reboot during installation.

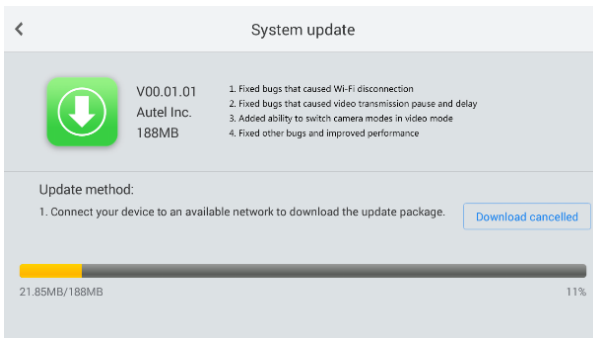

Figure 6-21 *Sample Display Tablet System Update*

7 Troubleshooting

Table 7-1 *Troubleshooting*

Symptoms	Possible Reason	Solutions
Display is on, but does not show image.	Cable connection is loose.	Check and reattach.
	Imager heads are covered by debris.	Check if it is covered by debris and remove it.
LED on imager heads are dim at max brightness, display tablet changes between monochrome and color mode, and then turns itself OFF after a short period.	Low battery.	Charge battery.
The tool cannot turn on.	Dead battery.	Replace battery.

8 Compliance Information

FCC COMPLIANCE **Display Tablet** **FCC ID: WQ8MAXIVIDEO500-1**

Handle **FCC ID: WQ8MAXIVIDEO500-2**

Both devices comply with Part 15 of the FCC Rules and with RSS of Industry Canada. Operation is subject to the following two conditions:

1. This device may not cause harmful interference.
2. This device must accept any interference received, including interference that may cause undesired operation.

Cet appareil est conforme aux CNR exempts de licence d'Industrie Canada. Son fonctionnement est soumis aux deux conditions suivantes:

1. Ce dispositif ne peut causer des interférences; et
2. Ce dispositif doit accepter toute interférence, y compris les interférences qui peuvent causer un mauvais fonctionnement de l'appareil.

WARNING

Changes or modifications not expressly approved by the party responsible for compliance could void the user's authority to operate the equipment.

NOTE

This equipment has been tested and found to comply with the limits for a Class B digital device, pursuant to Part 15 of the FCC Rules. These limits are designed to provide reasonable protection against harmful interference in a residential installation.

This equipment generate uses and can radiate radio frequency energy and, if not installed and used in accordance with the instructions, may cause harmful interference to radio communications. However, there is no guarantee that interference will not occur in a particular installation. If the equipment does cause harmful interference to radio or television reception, which can be determined by turning the equipment off and on, the user is

encouraged to try to correct the interference by one or more of the following measures:

1. Reorient or relocate the receiving antenna.
2. Increase the separation between the equipment and receiver.
3. Connect the equipment into an outlet on a circuit different from that to which the receiver is connected.
4. Consult the dealer or an experienced radio/TV technician for help.

Changes or modifications not expressly approved by the party responsible for compliance could void the user's authority to operate the equipment.

RF WARNING STATEMENT

The device has been evaluated to meet general RF exposure requirement. The device can be used in portable exposure condition without restriction.

The term "IC" before the radio certification number only signifies that IC technical specifications were met.

RoHS COMPLIANCE

Both devices are declared to be in compliance with the European RoHS Directive 2011/65/EU.

CE COMPLIANCE

This product is declared to conform to the essential requirements of the following Directives and carries the CE mark accordingly:

EMC Directive 2014/30/EU

R&TTE Directive 1999/5/EC

Low Voltage Directive 2014/35/EU

9 Warranty and Service

Limited One Year Warranty

Autel Intelligent Technology Corp., Ltd. (the Company) warrants to the original retail purchaser of this MaxiVideo MV500, that should this product or any part thereof during normal consumer usage and conditions, be proven defective in material or workmanship that results in product failure within 1 year period from the date of delivery, such defect(s) will be repaired, or replaced (with new or rebuilt parts) with Proof of Purchase, at the Company's option, without charge for parts or labor directly related to the defect(s).

The Company shall not be liable for any incidental or consequential damages arising from the use, misuse, or mounting of the device. Some states do not allow limitation on how long an implied warranty lasts, so the above limitations may not apply to you.

This warranty does not apply to:

- 1) Products subjected to abnormal use or conditions, accident, mishandling, neglect, unauthorized alteration, misuse, improper installation or repair or improper storage;
- 2) Products whose mechanical serial number or electronic serial number has been removed, altered or defaced;
- 3) Damage from exposure to excessive temperatures or extreme environmental conditions;
- 4) Damage resulting from connection to, or use of any accessory or other product not approved or authorized by the Company;
- 5) Defects in appearance, cosmetic, decorative or structural items such as framing and non-operative parts.
- 6) Products damaged from external causes such as fire, dirt, sand, battery leakage, blown fuse, theft or improper usage of any electrical source.

Service Information

If you have any questions, please contact your local store, distributor or visit our website www.autel.com.

Other Services

Accessories can be purchased from Autel authorized suppliers and your local distributors.